

# Softmaster<sup>®</sup> ROE compact

**Controller for reverse osmosis plants**



Operating instructions

# Table of contents

<b>General notes</b> .....	<b>3</b>	Menu start .....	19
Introduction .....	3	Menu selection / Selection .....	19
Handling notes .....	3	Input .....	19
Safety notes .....	3	Menu end .....	19
Installation and commissioning .....	3	Information menu .....	19
<b>General Description</b> .....	<b>4</b>	Programming .....	19
Views of the unit .....	4	Enter password .....	19
Description of display and operating features .....	5	Change password .....	19
Display functions .....	5	Flush .....	20
Display – top line .....	5	Interval Flush .....	20
Display – bottom line .....	5	Quality Flush .....	20
LED displays .....	6	Sensor CD Permeate .....	20
Operating displays .....	6	LV Permeat Max .....	20
Error messages .....	7	LV Permeat Min .....	20
<b>Terminal block identification</b> .....	<b>10</b>	Temperature compensation .....	21
Functions .....	10	Function Low water pressure, .....	21
Description of relay outputs .....	11	Function Excess pressure .....	21
PU, pressure pump .....	11	Function IN 4-20mA input .....	21
IV, input valve .....	11	Function Motor protection .....	22
FV, flush valve .....	11	Function Stop .....	22
PV, output valve .....	11	Function OUT DO/PV .....	22
DO, dosing output .....	12	Dosing .....	22
Fault message output ("Alarm") .....	12	Function OUT mA .....	22
Description of the signal inputs .....	13	Language .....	22
LP, low water level .....	13	<b>"SERVICE" Menu</b> .....	<b>23</b>
HP/MP, excess pressure/motor protection .....	13	Maintenance (manual flush) .....	23
HL and LL, full and empty level .....	14	Automatic flush .....	23
STOP, Switching off the plant .....	15	Error history .....	23
CD, Connection for conductivity sensor .....	15	Calibration of the conductivity sensor CD .....	24
PT100, Connection for temperature sensor PT100 .....	16	Operating hours .....	25
.....	16	Pressure .....	25
IN 4-20mA, Input for pressure sensor .....	16	Time / Date .....	25
OUT 0/4-20mA, Interface output .....	16	Diagnosis .....	25
.....	16	Software status .....	25
<b>Functions characteristics</b> .....	<b>17</b>	<b>Menu structure</b> .....	<b>26</b>
Switching on and power failure .....	17	<b>Technical Appendix</b> .....	<b>27</b>
Production/Run .....	17	Connection example .....	27
Standby .....	17	Conformity Declaration .....	29
Flush after production .....	17	Technical data .....	30
Interval Flush .....	17		
Quality flush and emergency service .....	17		
Conductivity monitoring .....	18		

# General notes

## Introduction

These operating instructions describe the installation, operation and programming of the reverse osmosis controller Softmaster ROE compact.

We recommend that, whilst familiarising yourself with the operation of the unit aided by this manual, you have immediate access to the operable controller in order to perform the functions and combinations as described. As certain functions are interrelated, it is advisable to follow the instructions in the given order.

Should problems or questions arise which are not described in this manual and/or cannot be solved, our customer service is always at your disposal.

Try to identify the problem as accurately as possible and record the conditions under which it occurred. This will enable us to offer you swift effective assistance.

## Handling notes

Quick, repeated switching on/off of the controller should be avoided. Wait at least 5 seconds before switching the unit either 'on' or 'off' at the main switch.

Only operate the controller in compliance with the ambient conditions (e.g. temperature, moisture) stated in the chapter entitled technical data. Especially protect the controller against moisture.

The controller should not come into contact with splash or condensation water.

Before dismantling a defect controller, always write down the description of the error (failure effect). Repair work (independent of the guarantee period) is only possible after the unit has been dismantled and returned to us with a description of the error.

The warranty shall not apply if the controller is tampered with, altered, modified or repaired contrary to the instructions described in this manual.

The allowed maximum electrical load capacity of the relay outputs and the total power rating of the plant must not be exceeded.

The controller should only be used for the stated intended purpose.

## Safety notes

Always pay attention to the following safety notes:

Only connect the device to the mains voltage displayed on the type plate. The controller must be installed and operated in compliance with the relevant standards (e.g. DIN, VDE, UVV), or in accordance with the regulations laid down by the individual country.

Some functions (e.g. manual production) allow direct manipulation of the plant (valves, pumps, etc.), without locking or monitoring. These functions are thus protected by a password and are only to be used by trained personnel.

If you observe malfunctioning of the controller, switch it off immediately and inform the service personnel. Do not attempt to repair the controller yourself (loss of warranty rights); instead always get in touch with authorized service personnel. This is the only way a reliable and safe operation of the plant can be ensured.

After protective equipment (safety fuse, motor protection circuit breaker) has been triggered, attempt, at first, to eliminate the cause of the malfunctioning (e.g. clean the pump) before reactivating the protective equipment. Frequent triggering is always due to an error which, in certain circumstances, may also cause damage to the controller.

Ignoring these notes can result in damage to the controller as well as the plant and may result in a loss of warranty rights.

## Installation and commissioning

### **Installation as well as commissioning must only be undertaken by authorized technicians!**

The connecting cables to the sensors should be kept as short as possible and **clear** of power cables. Close proximity to strong electromagnetic radiators can lead to deviations of the display; in this case, separate interference suppression measures should be carried out.

After installation, program the unit with the plant-specific features and data (e.g. switch functions, conductivity limit values, etc.). The data is permanently stored (also during power failure).

# General Description

## Views of the unit



Terminal box

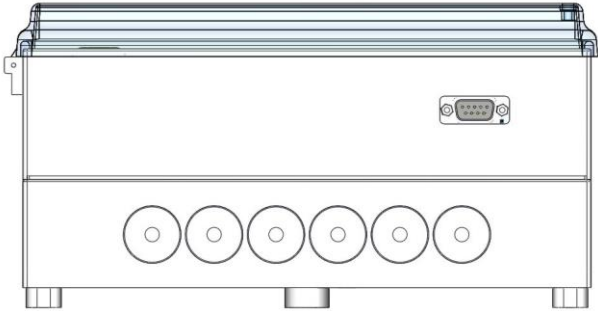

Serial interface RS232

## Drilling scheme

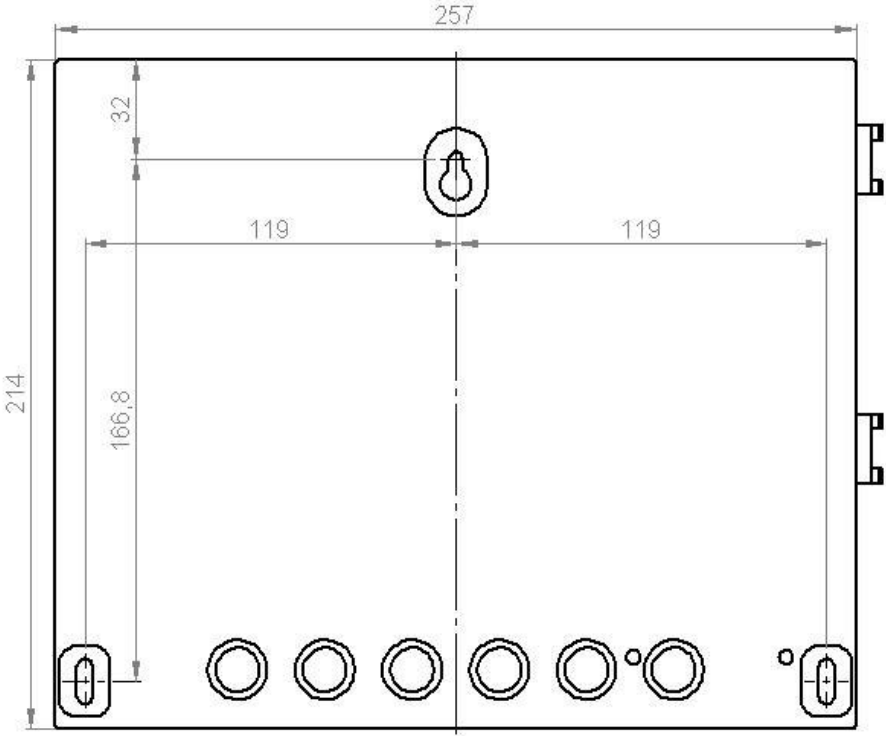

## Description of display and operating features

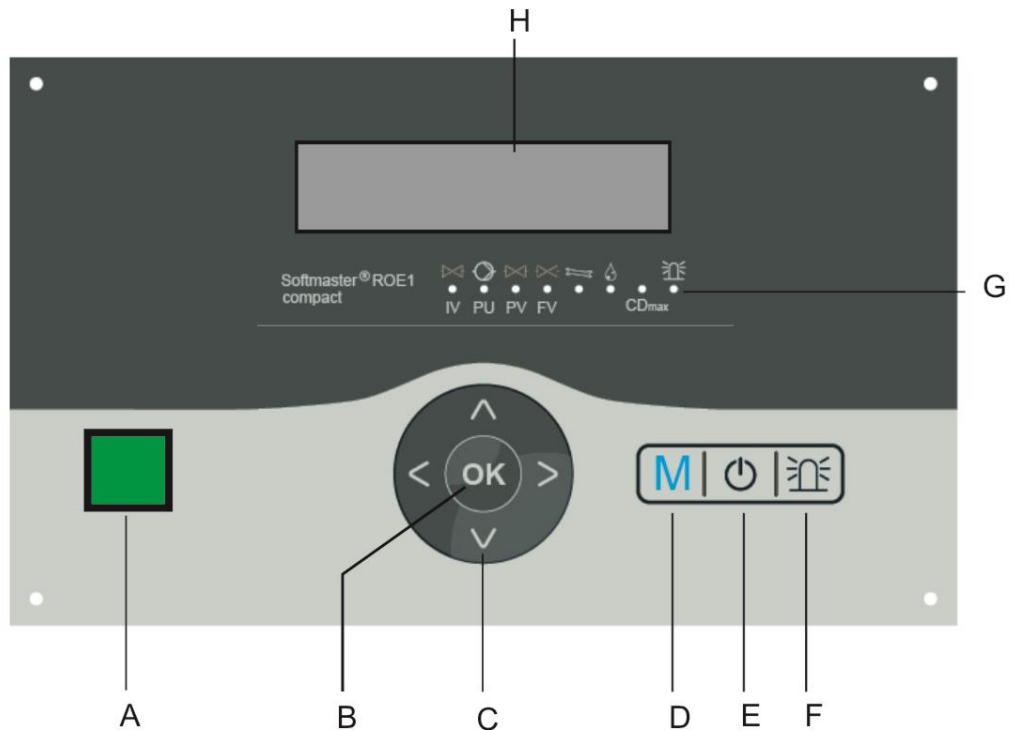

### A On/Off switch

Use this switch to switch the unit on or off.

### B ENTER" key

Confirm inputs and trigger functions with the ENTER key.

### C Arrow keys

Use these keys to operate the menu drive in the display and to enter values and programming data.

### D "M" key

Call the menu and return from submenu levels.

### E key (AProduction/Standby@)

Manual triggering of production: Plant is put into operation or manual triggering for STOP/ Standby: Plant goes into the Standby position.

### F key (fault OFF)

Deletes the alarm signal at fault message output; a fault display can only be deleted if the fault has been eliminated.

### G LED functions

LED symbols always signal the status of the plant, independent of the level (menu) being worked on.

### H LC display

Two lines, each line with 16 characters, backlit.

## Display functions

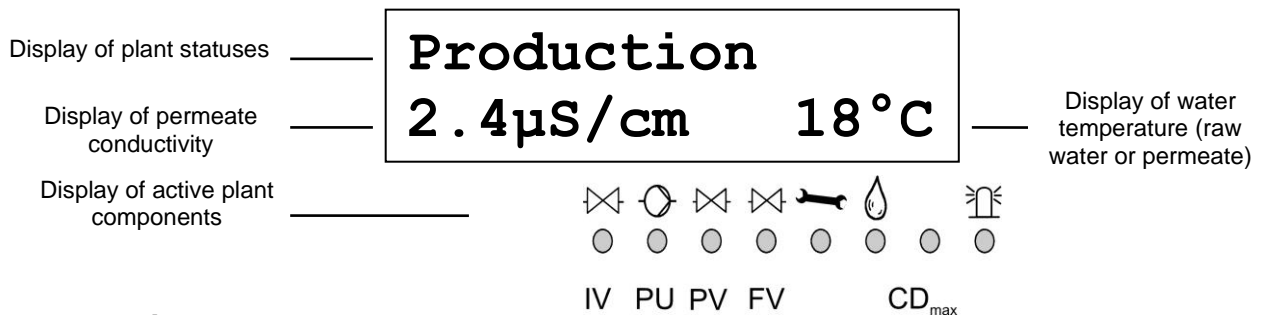

### Display – top line

The top line displays plant statuses and error messages (described below)

### Display – bottom line

The bottom line displays the conductivity (see technical data for measuring ranges) and water temperature (2-digit, only with automatic temperature compensation).

## LED displays

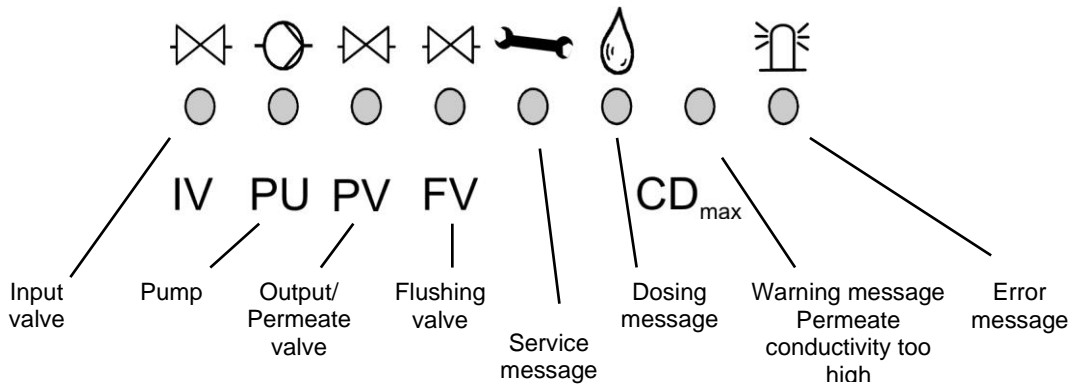

The LEDs display active plant components and occurring error messages.

### IV (green)

LED lights up: Input valve is open.

### PU (green)

LED lights up: Pump is switched on.

### PV (green)

LED lights up: Output/Permeate valve is open.

### FV (green)

LED lights up: Flush valve is open.

### Maintenance message (green)

LED lights up: Manual flushing is active (SERVICE maintenance).

### Dosing message (green)

LED lights up as long as the dosing output is activated.

### Warning message @Conductivity too high@ (yellow)

LED lights up: The limit value  $CD_{max}$  has been exceeded.

### Error message @Alarm@ (red)

LED lights up: Alarm relay has been activated, error message not confirmed yet and error still occurring.  
LED flashes: Alarm relay no longer active, error message has been confirmed but the error is still occurring.  
As long as an error is still occurring, it is shown alternately with the operating display.

## Operating displays

Production 12.3 $\mu$ S/cm    21°C
---------------------------------------

Plant is in operation and produces permeate with 12.3  $\mu$ S/cm of conductivity at a water temperature of 21°C.

Standby 243 $\mu$ S/cm
---------------------------

Plant is on Standby with a permeate conductivity of 243  $\mu$ S/cm.

Flush  10m
------------------

Flush program is active (flush after production, interval flush or started manually), residual time 10 minute.

Quality Flush  
197.3µS/cm

Quality flush during production is active with a permeate conductivity of 197.3 µS/cm. The LED @CD<sub>max</sub>@ lights up additionally.

Program the duration of the quality flush in the BASIC PROGRAM menu.

---

Maintenance  
89m

Manual flushing is active with current residual operating time of 89 minutes. The LED @Maintenance@ lights up additionally.

---

Stop

Plant has been stopped via the STOP input and is locked. It is only possible to restart production with the  key after the stop input has been released.

---

## Error messages

In addition to the displayed error messages, the red LED @Alarm@ lights up or flashes.  
Alternate display of all error messages and operating displays.  
Each occurred error is stored in the error history.

### Error message APower failure@

Power failure

or

Power failure  
set clock!

Message after each switching on: @power failure@. Acknowledge the fault display via the  key. Check the time and, if necessary, set the time. After this, the unit is without a real-time clock (plug-in card RTC/RS232).

After switching on or after voltage recovery, the controller starts with @STANDBY@. Check the plant for possible negative results due to the power failure.

All stored values remain stored even during power failure. The real-time clock is buffered and thus keeps running.

---

### Error message @CD Permeate Max@

CD Permeate Max  
64.4µS/cm

Permeate conductivity is greater than the set limit value @LV Permeate Max@

The maximum permeate conductivity has been exceeded for a longer period than the programmed test time (Delay<sub>Max</sub>) during production. The error message is displayed and, according to the programming, the plant has been switched off.

In addition to the error message, the yellow warning light @CD<sub>max</sub>@ lights up.

Acknowledge the fault display via the  key.  
Check the plant settings and raw water quality or check the units for possible defects.  
The error display is only deleted once the fault has been eliminated.

---

### Error message ACD Permeate Min@

CD Permeate Min  
1.2µS/cm

Permeate conductivity is less than the set limit value @LV Permeate Min@

The minimum permeate conductivity has fallen below the limit value for a longer period than the programmed test time (Delay Min) during production. The error message is displayed and, according to the programming, the plant has been switched off.

Acknowledge the fault display via the  key.

Check the conductivity sensor and its supply lines for interruption. There might be air in the permeate line and the sensor is not washed by water.

The error display is only deleted once the fault has been eliminated.

---

### Error message @Low water pressure@

Low water pressure  
16.8µS/cm 18°C

The pressure switch in front of the pressure pump for the dry-running protection has triggered.

The pressure switch in front of the pressure pump for the dry-running protection has triggered.

The plant has been switched off after the programmed delay time (Delay LP). Restart the plant via the  key. If water is still low, the plant is switched off again after the delay time.

When automatically controlling the re-filling of the storage tank, the plant is restarted 10 minutes after it was switched off via the dry-running switch.

Program the number of restart attempts after low water pressure under @Restart@ in the menu @Funct. low water pressure@.

Acknowledge the fault display via the  key.

The error display is only deleted once the fault has been eliminated.

---

### Error message @Excess pressure@

Excess pressure  
16.8µS/cm 18°C

The pressure switch behind the pressure pump for the protection of the units against excess pressure has triggered.

The plant has been switched off after the programmed delay time (Delay HP). Restart the plant via the  key. If renewed excess pressure occurs, the plant is switched off again after the delay time.

Acknowledge the fault display via the  key.

The error display is only deleted once the fault has been eliminated.

---



**Error message @Motor protection@** (only if input HP has been programmed as motor protection input)

Motor protection 16.8µS/cm    18°C
---------------------------------------

The motor protection circuit breaker of the pressure pump has triggered.

After triggering the protective switch, the plant has been switched off immediately. Restart the plant via the  key if the motor protection has been re-released.

Acknowledge the fault display via the  key.  
The error display is only deleted once the fault has been eliminated.

---

**Error message @Excess quality flushing duration has been exceeded@**

Max. Q.-flush time 196.2µS/cm
----------------------------------

Even after a quality flush, the permeate conductivity is still greater than the set limit value @LV Permeate Max@.

The error message is displayed and emergency service starts.

In addition to the error message, the yellow warning light @CD<sub>max</sub>@ lights up.

Acknowledge the fault display via the  key.  
Check the plant settings and raw water quality or check the units for possible defects.

The error display is only deleted once the fault has been eliminated.

---

**Error message @Temperature low@**

Temperature low 16.8µS/cm    0°C
-------------------------------------

The water temperature is lower than 1° C.

The water temperature during production has fallen below the minimum water temperature.  
Check whether short circuiting has occurred in the sensor or the temperature sensor PT100 or in their supply lines.

Acknowledge the fault display via the  key.  
The error display is only deleted once the fault (temperature > 2°C) has been eliminated.

---

# Terminal block identification

**Functions** (IN = input, OUT = output)

Terminal	Type	Function	Note
PE	IN	9x mains protective earth	
L N	IN	Mains, N = Neutral Mains, L = Live	Mains-input 230 - 240 V AC
I n	OUT	2x Neutral switched 2x Live switched	Mains voltage, max. 6 A
PU	OUT	Pump - Common Pump - Normally open	Volt-free relay output max. load 240 V AC, 6 A
IV	OUT	Input valve - Common Input valve - Normally open	Volt-free relay output max. load 240 V AC, 6 A
FV	OUT	Flush valve - Common Flush valve - Normally open	Volt-free relay output max. load 240 V AC, 6 A
C DO/PV NC* NO	OUT	Dosing/Output valve – Common Dosing/Output valve - Normally closed Dosing/Output valve – Normally open	Volt-free relay output max. load 240 V AC, 6 A
C AL NC NO	OUT	Fault message output - Common Fault message output - Normally closed Fault message output - Normally open	Volt-free relay output max. load 240 V AC, 6 A
LP	IN	Low water messages common loads for inputs	Only for volt-free normally open/normally closed contact!
HP GND	IN	Overpressure message/ext. motor protection common load for inputs	Only for volt-free normally open/normally closed contact!
HL GND	IN	Storage tank FULL common load for inputs	Only for volt-free normally open/normally closed contact!
LL GND	IN	Storage tank EMPTY common load for inputs	Only for volt-free normally open/normally closed contact!
STOP GND	IN	Stop plant common load for inputs	Only for volt-free normally open/normally closed contact!
CD OUT CD IN	IN	Conductivity electrode for permeate	
PT100	IN	Temperature sensor PT100	Water temperature (permeate or raw water)
GND 20mA IN	IN	common load Signal pressure sensor (optional)	4-20mA-input, see pressure input description
GND 20mA OUT	OUT	Current interface 0/4-20mA (standard)	- indirect-coupled

\* (NO = Normally open, NC = Normally closed; Normally means: switch position is current-free)

## Terminal blocks for mains supply and relay outputs (displayed relay position: Device deenergized)

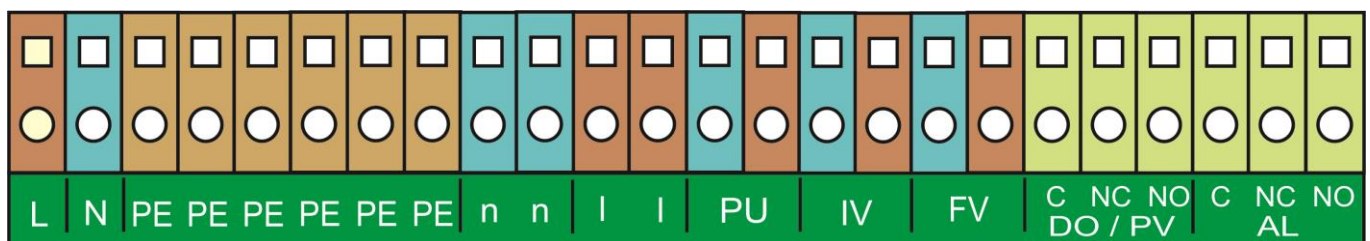

## Terminal blocks for inputs and interface

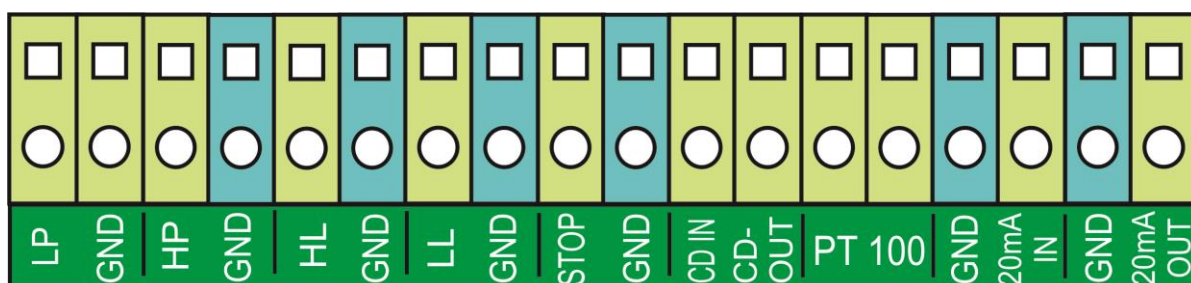

## Description of relay outputs

### PU, pressure pump

The pressure pump of the osmosis plant can be switched directly. Fuse protection occurs internally via a safety fuse T6.3A. When using a three-phase motor, an appropriate power protection contactor has to be pre-connected. The input valve always opens when switching to production. The pressure pump starts after a 10 second delay.

Select whether flushing should occur via a pump under menu option:

"M" ≡ BASIC PROGRAM ≡ FLUSH ≡ w.pump.

If the pump is equipped with a motor protection circuit breaker with a volt-free message contact, it is possible to connect it to input "HP". Activate the input in the menu. The controller will then monitor pump faults (see description of input HP motor protection).

### IV, input valve

The input valve is open during "Production@", "@Quality flush@" and "@Flush". It should be designed in a way to ensure that it opens under control voltage. Use the following menu option to program that the input valve is closed during flush:

"M" ≡ BASICPROGRAM ≡ FLUSH ≡ w. valve IV

### FV, flush valve

The osmosis plant can be equipped with a flush valve in order to avoid unacceptable high deposits at the units. Flushing can take place after "Production" and/or at fixed intervals after the last switching to the "Standby" position. Interval flush prevents unacceptable bacterial contamination of the units.

Flushing is interrupted as soon as the controller switches to "Production", e.g. when pressing the  key or if water is requested via a level transmitter in the storage tank.

No interval flush occurs after production stop.

Program the flushing duration (0 - 99 minutes), flushing mode (with/without pump or with/without input valve) and the flush interval in the basic program.

"M" ≡ BASIC PROGRAMM ≡ FLUSHING or INTERVAL FLUSH ≡ Duration

### PV, output valve (Permeate valve)

#### Only if output DO/PV has been programmed as PV!

This valve is open as long as the water conductivity is below the set limit value "LV Permeate Max". A flush valve which closes under voltage can be connected instead of the output valve. The use of both valves or of a 3/2-way valve is also possible.

Use the following menu option to program if you wish to use an output valve:

"M" ≡ BASIC PROGRAM ≡ FCT. OUT DO/PV ≡ Output valve PV

## DO, dosing output

### Only if output DO/PV has been programmed as DO!

Use the output DO to control a dosing pump if an anti-scaling medium is to be dosed during production or flush. The impulse ratio is adjustable.

Use the following menu option to program if you wish to use an output valve:

"M"≡BASIC PROGRAM ≡ FCT. OUT DO/PV ≡ Dosing DO

Example:

10-second impulses and a 10-second pause should occur during production:

"M"≡Basic program ≡ Dosing ≡ Production

"M"≡Basic program ≡ Dosing ≡ I. length 10s

"M"≡Basic program ≡ Dosing ≡ I. pause 10s

## Fault message output ("Alarm")

The fault message output (terminal C NC NO) is a volt-free change-over relay contact. During trouble-free operation the contact between the terminals C - NO is closed and the one between terminals C - NC is open. In case of power failure or a fault, the contact between the terminals C - NC is closed and the one between terminals C - NO is open. The controller monitors a whole range of plant statuses. The "AL" output remains activated (terminals C - NC closed) as long as the fault persists.

The red LED "Error message" and the text on the display indicate a fault.

The fault message signal at the fault message output is deleted by confirming the fault via the  key.

The fault display can only be deleted once the fault has been eliminated.

The following faults activate the fault message output and are displayed if you have equipped the osmosis plant with the respective sensors:

(NO = Normally open, NC = Normally closed; Normally means: switch position is current-free)

The following statuses **always** trigger a fault message:

Power failure

Low water level LP (after switching off)

Max. Q flush time has been exceeded

Min. conductivity not achieved

Max. conductivity has been exceeded

Cond. measuring range not achieved

Max. water temperature exceeded

Min. water temperature not achieved

Max. pressure exceeded

According to programmed HP input:

Motor protection MP or

overpressure HP

See page 6 for further descriptions of error messages and programming.

## Description of the signal inputs

### Note

Only connect the signal inputs "LP", "HL", "LL", "HP", "STOP" to **volt-free** contacts!

### LP, low water level

Connection for volt-free pressure switch

Function	Type of contact	Test time	Action
Pressure monitoring in front of the pump	programmable normally closed/ normally open	programmable 01 - 99 seconds	programmable - Restart up to 9 x <b>Not</b> programmable - Switching off the plant - Continuous alarm after switch off - Entry in error list

Install a maximum pressure governor in front of the pump to protect the pressure pump. A serial or parallel connection of two maximum pressure governors is also possible.

If the maximum pressure governor switches, the plant is switched off after a programmable test time. The fault is displayed via the red LED "Error message" and on the display. A continuous alarm occurs at the fault message output and the fault is entered in the error list.

"M"≡Basic programm ≡ Fct. Low water level

It is possible to program the reaction of the controller during low water. Determine how often the plant is to be restarted. Restart occurs after 10 minutes (fixed). If the water is still too low, the plant is once again switched off after the test time and until the number of restarts has been reached.

There is no restart via the  key (AProduction/Standby@) at a hand start!

### Note!

When operating the osmosis plant without a pressure governor for low water identification, the connection "LP" has to be bridged or programmed as normally open.

## HP/MP, excess pressure/motor protection

Use this input for connecting a maximum pressure governor or monitoring the pressure pump. Program the required function in the menu.

### MP, Motor protection

If you are using pumps equipped with a motor protection circuit breaker with a volt-free message contact, it is possible to connect it to input "HP". Please program the operating mode of the message contact accordingly.

A pump fault is then monitored and evaluated by the controller.

"M"≡Basic program ≡ Fct. Motor protection ≡ ON

Function	Type of contacts	Test time	Action
Message contact of an external motor protection circuit breaker	programmable normally closed/normally open	2 seconds	S Switch off S Continuous alarm S Entry in error list

## HP, overpressure

Connection for volt-free pressure switch

"M"≡Basic program ≡ Fct. Overpressure ≡ Contact HP/MP

Function	Type of contacts	Test time	Action
Monitoring of the pressure in front of or behind the unit programmable	normally closed/ normally open	programmable 01 - 99 seconds	– Switching off the plant – Continuous alarm – Entry in error list

Install a maximum pressure governor either at the raw water side or at the concentrate side in order to protect the unit. A serial or parallel connection of two maximum pressure governors is also possible.

If the pressure governor switches, the plant is switched off after a programmable test time. The red LED "Error message" and the text on the display indicate the fault. A continuous alarm occurs at fault message output "C NC NO" and an entry in the error list occurs.

Restart the plant via the  key. If excess pressure still occurs, the plant is switched off again after the test time.

### Note!

When operating the osmosis plant without a maximum pressure governor, the connection "HP" has to be bridged and programmed as normally open or @MP@ input.

## HL and LL, full and empty level

Connections for volt-free contacts

Function	Type of contacts	Test time	Action
<b>HL</b> Level transmitter input A Full level@ Pressure switch input	Normally closed	2 seconds	S Stop production (when a full level transmitter has been connected) S Start production (if a pressure switch has been connected)
<b>LL</b> Level transmitter input "empty level"	Normally open	2 seconds	S Start production (when an empty level transmitter has been connected)

You can use the connections "HL" and "LL" for controlling the production:

a) For plants with a storage tank:

Once the low level "Tank empty" ("LL" connection) has been reached, the contactor closes and the plant is switched on ("Production@). It is only switched off again once the upper level "Tank Full" ("HL" connection) has been reached and this contactor is opened.

Instead of two level transmitters it is also possible to operate with just one upper level transmitter (floating switch) or a remote switch (Production/Standby). Connection "LL" then has to be connected to "⊥" via a bridge. The  key ("Production / Standby") will then be without function.

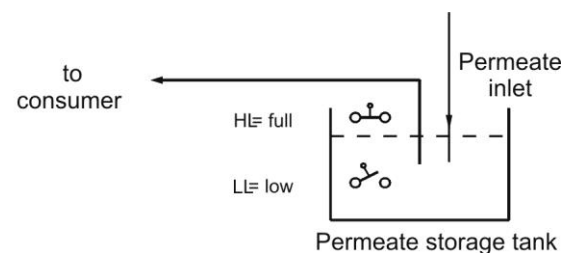

### Note!

When using automatic concentrate displacement via permeate (flush), observe that, depending on the pressure ratios, soft water can still run into the storage tank until the end of the flushing duration. Due to this, the upper level transmitter has to be arranged in a way that a tank overflow is avoided. For safety reasons, the tank should have a tank overflow to the drain.

It is possible to install a level transmitter above the @Full level@ in order to switch off the plant in case of a tank overflow.

Connect this switch to the signal input "STOP". The plant automatically switches off if the "Tank overflow level" has been reached.

**Note!**

When operating the osmosis plant without a level transmitter (manual operation), a bridge has to be connected across the connection @HL@. A bridging of the connection "LL" is **not** allowed.

b) For plants with one pressure switch or remote control switch:

Connect a bridge to the connection "LL" and the pressure switch to the connection "HL". The pressure switch must have a normally closed contact.

**STOP, Switching off the plant**

Connection for volt-free contact

Function	Type of Contact	Test time	Action
External switching off the plant	programmable normally closed/ normally open	programmable 01 - 99 Seconds	S Switching off the plant

During production, it might be necessary to interrupt the production externally via a switch. In the case of pre-connected single filter plants, the osmosis plant should not switch to @Production@ during regeneration in order to avoid operation of the units with hard water.

Interval flush is suppressed via the function "STOP".

If the input is activated (as normally closed or normally open), the plant switches off (display @Stop@).

"M"≡ Basic program ≡ Fct. Stop

**CD, Connection for conductivity sensor**

The unit is equipped with a measuring amplifier for conductivity measurement

The conductivity sensor at connection CD IN/CD OUT measures and monitors the permeate conductivity

Different measuring ranges arise due to the connection of sensors with varying cell constants

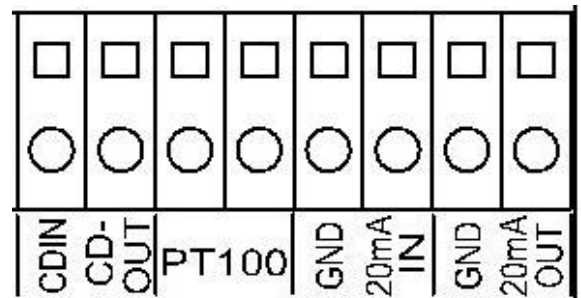

Measuring range	Cell constant	Sensor name, e.g.
0,1 - 200 µS/cm	0,01 cm <sup>-1</sup>	SOE0, STE0 PT100
1 - 2000 µS/cm	0,1 cm <sup>-1</sup>	SO1, ST1 PT100, SOE1
5 – 10000 µS/cm	0,5 cm <sup>-1</sup>	SO5, SOE5, ST5 PT100
10 – 20000 µS/cm	1,0 cm <sup>-1</sup>	SD10, SO10
100 – 100000 µS/cm	5,0 cm <sup>-1</sup>	STE50 PT100

**If the measuring range is exceeded, "OFL" appears in the conductivity display and the error message @Exceed range CD@ is additionally displayed.**

Program the used cell constant of the permeate monitoring under:

"M"≡ Basic program ≡ Sensor Permeate

It is possible to use deviating cell constants by calibrating the sensor with a conductivity calibration solvent. Use @dry@ or zero point calibration to balance measured value distortions due to cable capacities. For this task, please observe the description about calibration.

See the function description @conductivity monitoring@ for information about the functionality of the limit values.

## PT100, Connection for temperature sensor PT100

Function	Connection	Test time	Action
Temperature compensation	PT100, integrated in sensor or external	none	Temperature compensation factor programmable 0.1 - 9.9%/°C
Temperature monitoring	PT100, integrated in sensor or external	none	At temperature < 1°C: – Continuous alarm – Entry in error list

Both functions can be used simultaneously.

Please connect a **temperature sensor PT100** to the input "PT100" if automatic temperature compensation (of the conductivity) is to be used; preferably use a conductivity sensor with integrated PT100. It is also possible to use a separate temperature sensor, but it has to be installed near the conductivity sensor.

"M"≡Basic program ≡ Temp.-comp.

## IN 4-20mA, Input for pressure sensor

The pump pressure in front of the unit is measured via a pressure transmitter at connection @IN 4-20mA@. Only use sensors with a 4-20mA output signal.

**If you wish to activate overpressure monitoring, please select output @IN mA@ under @Fct. overpressure@.**

It is possible to program the measuring range of the used pressure transmitter:

"M"≡Basic program ≡ Fct. IN 4-20mA ≡ max. pressure

It is possible to program the limit value for overpressure monitoring:

"M"≡ Basic program ≡ Fct. IN 4-20mA ≡ LV pressure

The current pressure can be requested in the service menu:

"M"≡ Service ≡ Pressure

## OUT 0/4-20mA, Interface output

Function	Connection	Test time	Action
Current interface 0/4 - 20 mA	Load max. 400 Ohm	-	– Conductivity Permeate 0-20mA or 4-20mA

It is possible to change the output function in the menu:

"M"≡Basic program ≡ Fct OUT mA



## Functions characteristics

### Switching on and power failure

After switching on the instrument and after each power failure, the plant automatically returns to the Standby position. Prior to the Standby position another flush takes place according to the programmed flushing duration (see programming). The plant can either be switched on manually by pressing the  key ("Production/Standby") or automatically, e.g. via existing level transmitters in the storage tank.

### Production/Run

Use the  ("Production/Standby") key to switch on the pressure pump of the osmosis plant. The control lamp @Pump@ (@PU@) lights up, the input valve opens (LED IV lights up) and after a delay time the motor of the pressure pump starts. During production it is possible to monitor the raw water pressure in front of the pressure pump (dry-running protection) as well as the pressure behind the pressure pump (overpressure protection) via pressure switches if the plant is equipped with the appropriate sensors. Additionally, the permeate conductivity is measured, displayed and compared with a minimum and maximum limit value.

The switching on and off can also take place automatically via level transmitters in the storage tank if the osmosis plant is equipped with a storage tank.

It is possible to interrupt the production temporarily via an external switch (input "STOP") in order to, e.g., regenerate a pre-connected softening plant.

### Standby

Press the  ("Production/Standby") key if water is no longer required. The pressure pump is switched off and the display shows "Standby". The switching on and off can also take place automatically via level transmitters in the storage tank if the osmosis plant is equipped with a storage tank. In the case of plants with a flush valve, there is a re-rinsing phase (flush after production) prior to the position "Standby". During this time, @Flush@ is shown on the display and the control lamp @flush valve@ (@FV@) lights up

When switching from production to flush, the pressure pump is - with opened input and flush valve - switched off for 5 seconds in order to achieve a pressure compensation of the plant.

The water pressure in front of and behind the pressure pump, the concentrate flow as well as the conductivity limit values are not monitored in @Standby@.

### Flush after production

The osmosis plant can be equipped with a flush valve (connection "FV") in order to avoid unacceptable high deposits at the units. Flush is started after the end of production if the storage tank is filled or by pressing the  ("Production/Standby") key. Program the necessary flushing duration in the basic program under "Flushing duration". Please set the flushing duration to 0 minutes if no flush is to take place after production.

Flushing is cancelled as soon as the  ("Production/Standby") key is pressed or if water is requested via a limit transmitter in the storage tank.

### Interval Flush

After the last switch off (in Standby), flushing can occur at fixed intervals. Interval flush prevents unacceptable bacterial contamination of the units. Enter the interval time (0 - 999 hours) and the flushing duration (1 B 99 minutes) in the basic program ("Interval flush").

Flushing is cancelled as soon as the  ("Production/Standby") key is pressed or if water is requested via a limit transmitter in the storage tank.

No interval flush occurs after production stop.

### Quality flush and emergency service

During production, it is checked whether the permeate conductivity rises above the upper limit value (LV Permeate Max). If it is too high and **quality flush** (Quality flush: ON) has been programmed, but not if conductivity is too high (LV Permeate Max: Switch off), a quality flush is started for the programmed duration after the end of the set test time for the upper limit value.

It is switched back to production if the permeate conductivity falls again due to the flush. However, if the permeate conductivity remains too high, the **emergency service** starts after the quality flush. The storage tank is filled in spite of the excessive conductivity. The emergency service is not shown extra on the display (display: @Production@).

The emergency service is terminated as soon as the conductivity falls below the upper limit value.

## Conductivity monitoring

The integrated conductivity measuring instrument is used for the quality monitoring of the plant.

**"OFL" appears on the display if the measuring range is exceeded.**

Temperature compensation of the conductivity can either take place automatically or manually with a programmable compensation factor. Sensors with PT100 temperature sensors (or external sensors) have to be used for the automatic compensation. In the case of manual compensation (suitable with constant water temperature), enter the temperature. See @Description of the inputs: PT100" for further explanations.

### Description of the functionality and programming of the conductivity limit values:

**LV Permeate Max:** Maximum conductivity value which should guarantee sufficient water quality.

"M" ≡ BASIC PROGRAM ≡ LV Permeate Max

**LV Permeate Min:** Minimum conductivity value which is necessary due to the existing raw water quality But if conductivity does fall below this value, there is an error in the plant or the controller is present (e.g. in the case of an interruption between controller and measuring sensor = parting of a cable).

"M" ≡ BASIC PROGRAM ≡ LV Permeate Min

The functionality of the limit values is stated in the table below:

Limit value	Test time	Action
LV Permeate Min <b>fallen below</b>	programmable 1 - 99 seconds	<ul style="list-style-type: none"> <li>- Continuous alarm</li> <li>- Entry in error list programmable</li> <li>- Switching off the plant</li> </ul>
LV Permeate Max <b>exceeded</b>	programmable 1 - 99 minutes	<ul style="list-style-type: none"> <li>- LED display ACDmax@ lights up</li> <li>- Continuous alarm</li> <li>- Entry in error list programmable</li> <li>- Switching off the plant</li> </ul>

# Programming

## Menu start

Use the "M" key to open the menu.

## Menu selection / Selection

The current line position is displayed as a header in CAPITAL LETTERS. Use the "ENTER" key to activate the selected/displayed menu item, i.e. you @jump@ into a submenu. The next menu item is called via the "DOWN" arrow key: You can "scroll" the menu.

## Input

**Inputs are only possible in the BASIC PROGRAMM menu and in certain SERVICE menu items.**

Select a programming step via the arrow keys "DOWN" and "UP" and activate the input function by pressing the "ENTER" key.

The first digit/position to be changed flashes when entering digits.

Use the arrow keys "Right" and "Left" to change to the next or previous digit (now flashing).

Use the arrow keys "DOWN" and "UP" to change the value or the selection.

With selection options, selected functions are labelled with a T.

Exit the input function via the "ENTER" key.

Use the "M" key to go to the superordinate menu.

## Menu end

Use the "M" key to jump to the superordinate menu. After returning from the highest menu level, the unit is in display mode again. The controller returns to the normal operating display (automatic menu end) if no key is pressed in the menu during a 2-minute period.

## Information menu

"M" → Information

In the information menu it is possible to request the current settings without entering a password. The information menu is still displayed even if an incorrect password has been entered.

## Programming

"M" → Basic program

## Enter password

The programming menu is protected by a 3-digit password (number between 000 and 999) in order to prevent unauthorised access to the programming.

Enter the password under

"M" ≙ Basic program ≙ Password entry and confirm the entry via the AENTER@ key.

You are now in the **BASIC PROGRAMM** menu

## Change password

Enter or change your individual password at any time.

To achieve this, enter the old password (OLD: ) and then the new one (NEW: ).

"M"



MENU
Service
Information
Basic program

BASIC PROGRAM
Password input
Password change

## Flush

It is possible to select and combine the units which are to be activated during flush as desired:

- With/without pump
- With/without input valve IV
- PV (Permeate valve)

Also enter the desired duration for the re-rinsing (also see @Flush after production@). The flush valve FV is generally active for the duration of the flush.

FLUSHING MODE	
with pump	✓
with valve	✓
Duration	1m
PV	✓

When selecting a PV, the permeate valve is closed for all flush types (interval, quality flushes) and for a conductivity higher than the limit value LV Permeate Max. This setting is only effective if the output valve PV has been selected under "FKT. OUT DO/PV".

## Interval Flush

Enter the interval for the automatic flush during standstill of the plant in hours and the desired duration in minutes.

There is no interval flush if 0 hours is entered.

The components selected under @Flushing mode@ as well as the flush valve FV are active during interval flush.

INTERVAL FLUSH	
Interval	90h
Duration	2m

## Quality Flush

Depending on the permeate conductivity (quality), it is possible to start a flush during production. If the limit value LV Permeate Max is exceeded, the unit is flushed for the entered duration.

If the permeate conductivity is still too high after the flushing duration, the production is going on despite high conductivity (emergency service) and an alarm message "Max. Q. flush time" is displayed.

If Quality flush has been selected and no Switch off has been selected under LV Permeate Max, the control ("PV" selected) goes into standby after the quality flush. Emergency operation is then not possible. The alarms "CD Permeate Max" and "Max Q. flush time" are also triggered.

QUALITY FLUSH	
On	
Durat. max	5m

## Sensor CD Permeate

Program the cell constant C of the used conductivity sensor:  
(Possible values: 0.01 B 5.0/cm)

PROBE CD PERMEAT	
C =	1.00/cm

## LV Permeat Max., Maximum limit value permeate conductivity

### Max.:

Enter the maximum conductivity which should guarantee sufficient water quality.

### Delay Max.

Delay time in minutes after which an alarm is triggered and/or the plant should be switched off if the maximum limit value has been exceeded.

### Switch off

Program @Switch off@ if the plant should be switched off after the end of the delay time if the maximum limit value has been exceeded.

LV PERMEAT MAX	
Max.:	100.0µS/cm
Delay Max	10m
Switch off	✓

## LV Permeat Min., Minimum limit value permeate conductivity

### Min.:

Minimum conductivity value which is necessary due to the existing raw water quality. If the conductivity falls below this value, an error in the plant or the controller is present.

### Delay Min.

Delay time in seconds after which an alarm is triggered and/or the plant should be switched off if the value has fallen below the minimum limit value.

LV PERMEAT MIN	
Min.:	1.0µS/cm
Delay Min	20s
Switch off	✓

### Switch off

Program @Switch off@ if the plant should be switched off after the end of the delay time if the value has fallen below the minimum limit value.

## Temperature compensation

### Automatic/manual

Please connect a **temperature sensor PT100** to the connection @PT100" and program automatic compensation if the temperature compensation of the conductivity should occur automatically.

TEMP.-COMPENS.	
automatic	-
Manual	✓
Factor	2.00
Temp.	25°C

### Factor (temperature coefficient in %/°C)

Enter the temperature compensation factor of the medium to be measured. The value for natural water is approx. 2%/°C. Use reference measurements to determine the temperature coefficient for ultra-pure water and with very small conductivities:

First, program the factor to 1.0 and measure the conductivity and the temperature of the medium at a temperature T1. Then measure the same medium at a temperature T2. Use the following formula to calculate the factor:

$$\text{Factor} = \frac{((\text{Conductivity (T1)} / \text{Conductivity (T2))} - 1)}{(T1 - T2)}$$

### Temperature

Please enter the existing water temperature for the manual compensation

## Function Low water pressure, Input low water pressure monitoring LP

Program the desired effect of the connected contact for low pressure monitoring, normally closed or normally open.

### Delay LP

Delay time in seconds after which an alarm is triggered and/or the plant should be switched off if the water/pressure is low.

### Restart

Program how often the plant is to be switched on again after the switch off caused by low water pressure. The plant can be re-started up to 9 times until the final switch off.

FCT.LOW W.PRESS	
norm. closed	-
norm. open	✓
Delay LP	5s
Restart	3x

## Function Excess pressure

Input excess pressure monitoring HP or 4-20mA signal of the pressure transmitter.

Program the used signal input, the desired effect of the connected contact for monitoring the pressure pump and the delay time.

### Delay HP

Delay time in seconds after which an alarm is triggered and/or the plant should be switched off if the pressure is too high.

## Function IN 4-20mA input

Program the measuring range of the sensor and the limit value for monitoring excess pressure if the osmosis plant is equipped with a pressure measuring transducer for the measurement of the pump pressure:

Request the current pressure in the SERVICE menu, e.g.:

"M" ≡ Service ≡ Pressure 14.3bar

FCT.EXC PRESS.	
IN mA	-
Contact HP/MP	✓
norm. closed	-
norm. open	✓
Delay HP	10s

FCT. IN 4-20mA	
max.press.25bar	
LV HP: 3.0bar	

### Function Motor protection, Input motor protection monitoring HP/MP

Program the activation and the desired effect of the connected contact for monitoring the driving motor of the pressure pump.

**The 2-second delay time after which an alarm is triggered and the pump is switched off is predetermined and cannot be changed.**

FCT.MOTOR PROT.	
ON	-
norm. closed	
norm. open	✓

### Function Stop, Input Stop

Program the desired effect of the connected contact for the switch off of the plant, normally closed or normally open.

#### Delay Stop

Delay time in seconds after which the plant should be switched off.

FCT. STOP	
norm. closed	
norm. open	✓
Delay Stop	1s

### Function OUT DO/PV, Output Dosing or permeate valve

#### DO dosing

If you wish to dose during operation, use output DO/PV as the impulse output for controlling a dosing pump.

FCT. OUT DO/PV	
Dosing DO	-
Output-V. PV	✓

#### PV output valve (permeate valve)

As an alternative, you can use the output to control a permeate valve. This valve is open as long as the water conductivity is below the set limit value "LV Permeate Max". A flush valve which closes under voltage can be connected instead of the output valve. The use of both valves or of a 3/2-way valve is also possible.

For an external stop, the permeate valve is closed and the flush is triggered. After the flush, the control goes into standby.

The permeate valve is closed in standby mode.

### Dosing

**Only possible if output DO/PV has been programmed as dosing output!**

(If dosing has not been programmed, @no dosing@ is displayed!).

Program the operating position of the plant during which dosing is to take place, the impulse pause and impulse length.

Please observe:

Relays mechanically possess a max. of  $10 \times 10^6$  switching cycles

DOSING	
Flush	-
Production	✓
I.Pause	1s
I.Duration	1s

### Function OUT mA

Program the current range of the installed current interface according to its use.

FCT. OUT mA	
0-20mA	✓
4-20mA	-

### Language

Selection of the desired language for the display:

Six @standard@ languages are currently available. If desired other language versions are also possible

LANGUAGE	
German	✓
English	
French	
Italian	
Polish	
Dutch	

## “SERVICE” Menu

Request and change current settings and statuses of the instrument in the Service menu.

### Maintenance (manual flush)

Start a flush of the plant via this manual function. After the start a return to the operating display occurs. The maximum flushing duration is limited to 99 minutes.

End the maintenance with the  key.

Maintenance 99m
--------------------

### Automatic flush

Start a flush of the plant with the programmed flushing duration via this manual function:

(s.a. "M" ≡ Basic program ≡ Flush ≡ Duration)

After the start a return to the operating display occurs.

It is possible to end the flush at any time with the  key.

FLUSH 1m
-------------

### Error history

Open the error history via @display@. The error history is a list of the errors which have occurred during current operation.

The occurred error is recorded with error number, time and date,

e.g.:  
Low w. press 6  
16:56 16.09.03

ERROR HISTORY
display
clear

The errors are stored in a ring buffer with a maximum of 20 errors, i.e. the oldest error is overwritten by the new one if the memory is full.

The memory of the error history is deleted via @clear@ and recording is started anew.

The list is not deleted after a power failure.

## Calibration of the conductivity sensor CD

Calibration should only take place with calibration solvents in accordance with DIN EN 27888!  
Inappropriate calibration leads to undefined display values!

### Dry and zero point calibration

With the **calibration method CAL. CD ZERO** it is possible to compensate measuring errors (offset) which occur due to very long supply lines to the measuring sensor.

The sensor is calibrated @dry@, i.e. it is not dipped into the measuring medium:

- Either with a built-in sensor, before the tube system is filled or
- with a not yet built-in sensor, but already equipped with the correct cable length.

Call the following menu option to start calibration

"M"≡Service ≡ Cal. CD Zero and start by pressing AENTER@.

The unit now corrects the measuring error caused by the cable length via subtraction. The process ends automatically.

CALIBRATE CD
Cal.CD Zero
Cal.CD Value
Cal.CD Start
Cal.CD Reset

### Desired value calibration

With the **calibration method CAL. CD desired value** it is possible to correct measuring errors caused by a soiled sensor.

It is recommended to also calibrate with this method if there are high accuracy demands in a small measuring range. This calibration method also enables measurements with a sensor whose cell constant is not exactly known.

Procedure:

Carry out the calibration with an appropriate KCl standard calibration solvent. For this, dip the measuring sensor into the calibration solvent. Please observe that the sensors are free moving in the vessel.

- **With automatic temperature compensation:** First, enter a temperature coefficient of 1.90%/C in the BASIC PROGRAM menu @Temp. comp.@ and the value of the standard calibration solvent at 25/C under desired value. After dipping the sensor into the calibration solvent, wait approx. 2 minutes before starting the calibration until the sensor has the same temperature as the solvent.
- **With manual temperature compensation:** If you wish to calibrate a sensor without a temperature transmitter, you have to enter "manual temp. compensation" in the basic program and the temperature of the calibration solvent under "Temperature". A temperature of 25°C for the calibration solvent is also valid here.

1. Call the menu @Calibrate CD@

"M"≡Service ≡ Cal. CD desired calibration

2. Enter the desired value of the conductivity and save the value by pressing @ENTER@.

3. Call the following menu option to start calibration

"M"≡Service ≡ Cal. CD start and start by pressing AENTER@.

The unit now corrects the measuring error by forming a correction factor. The calibration ends automatically.

### Note!

Inappropriate calibration can lead to the display of undefined values. Incorrect calibration can only be corrected via a new calibration or via a @CAL. CD RESET@.

### Note for calibration:

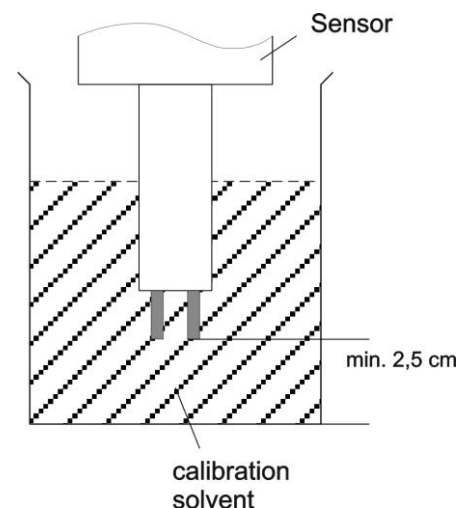



## Operating hours

The instrument records operating hours of the pressure pump/s and thus the load of the units.

The current operating time can be requested in the service menu:

"M"≡Service ≡ Operating hours

OPERATING HOURS
0 h

### Resetting the operating hour meter:

After replacing the pump/s or the units, it is possible to reset the current operating time to 0 hours.

"M"≡Service ≡ Operating hours ≡ Reset

## Pressure

The current pressure can be requested in the service menu:

Measuring input IN 4-20mA for the connection of a pressure transmitter with a 4-20mA output is used for the pressure monitoring of the pump or the unit. Please program the measuring range of the used pressure transmitter in the BASIC PROGRAM menu:

"M"≡Basic program ≡ Fct. IN 4-20mA ≡ max. pressure

PRESSURE
0.0bar

## Time / Date

Please observe that in the case of units without a clock module the time only runs if the unit is switched on. After a longer period of power failure or if the plant was switched off, the time and date should, if necessary, be corrected.

TIME	DATE
00:00	01.01.01

**Display:** "M"≡Service ≡ Time Date

The date and time of the controller are shown in the display.

**Setting:** Press the "ENTER" key under menu "M"≡Service ≡ Time Date

Set the time and date by selecting and activating the desired function via the arrow keys and the "ENTER@ key. Subsequently press the "ENTER" key again to save the setting and to return to the display function.

## Diagnosis

The actual statuses of the inputs and outputs are displayed in the diagnosis menu. The statuses of the inputs can be manually manipulated via the @DOWN@ and @UP@ keys for test purposes, e.g. when commissioning. Please ensure that downstream plant components cannot be damaged.

Active statuses (switched relay, connected input) are displayed via @on@, inactive statuses via @off@, e.g.:

**OUTPUT IV**                    or            **INPUT LP**  
    **off**                                    **on**

The analogue input displays the existing value, e.g.:

**INPUT MA**  
 16.8mA

DIAGNOSIS
OUTPUT PU
OUTPUT IV
OUTPUT FV
OUTPUT DO/PV
OUTPUT AL
OUTPUT mA
INPUT LP
INPUT HP/MP
INPUT HL
INPUT LL
INPUT Stop
INPUT mA

## Software status

Request the current software status here:

SOFTWARESTAND
93Mxxx TT.MM.JJ

# Menu structure

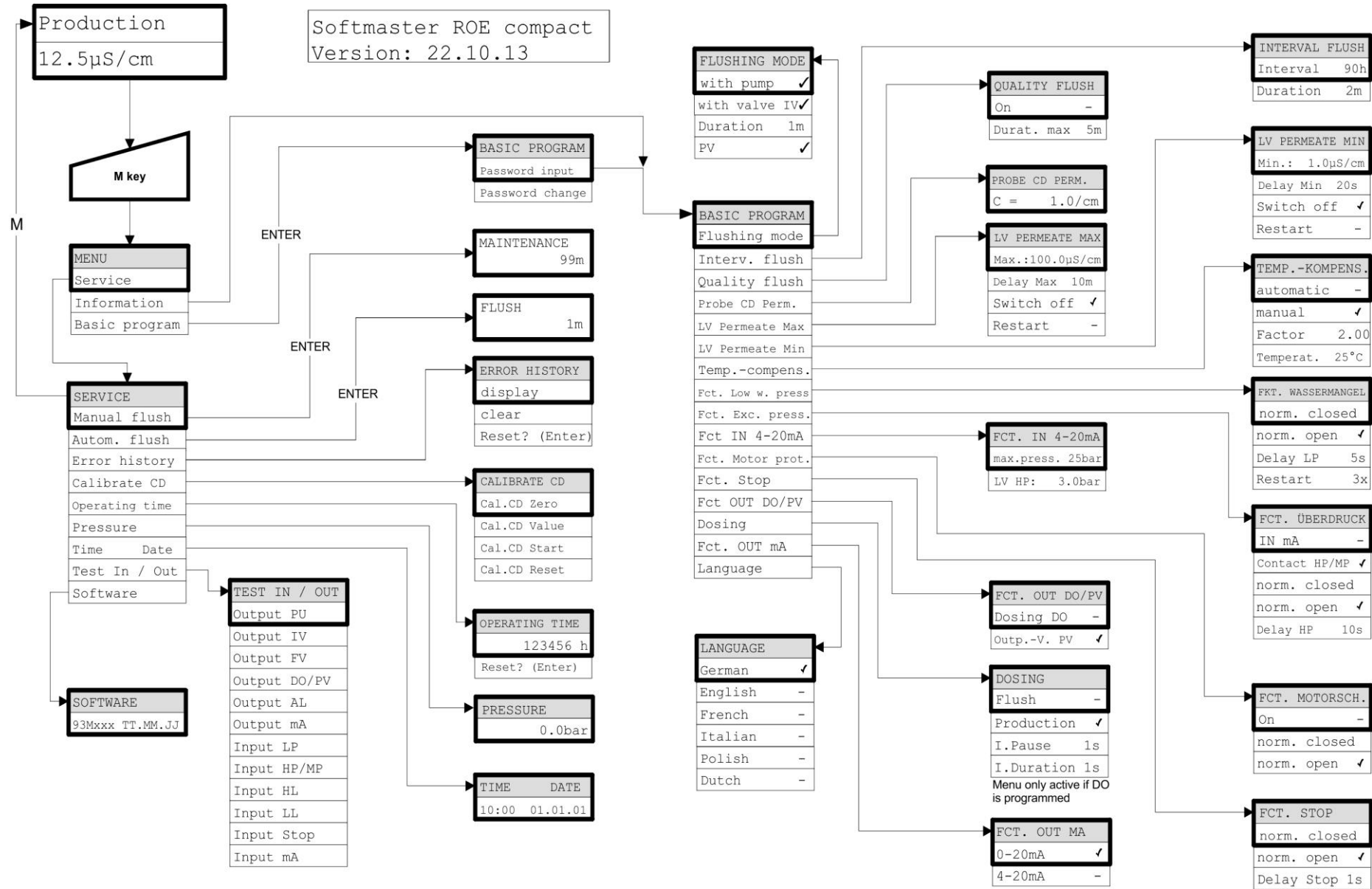

In order to call the factory>s basic setting, switch the unit on while pressing the @DOWN@ key. Your individual programming will be lost!

# Technical Appendix

## Connection example

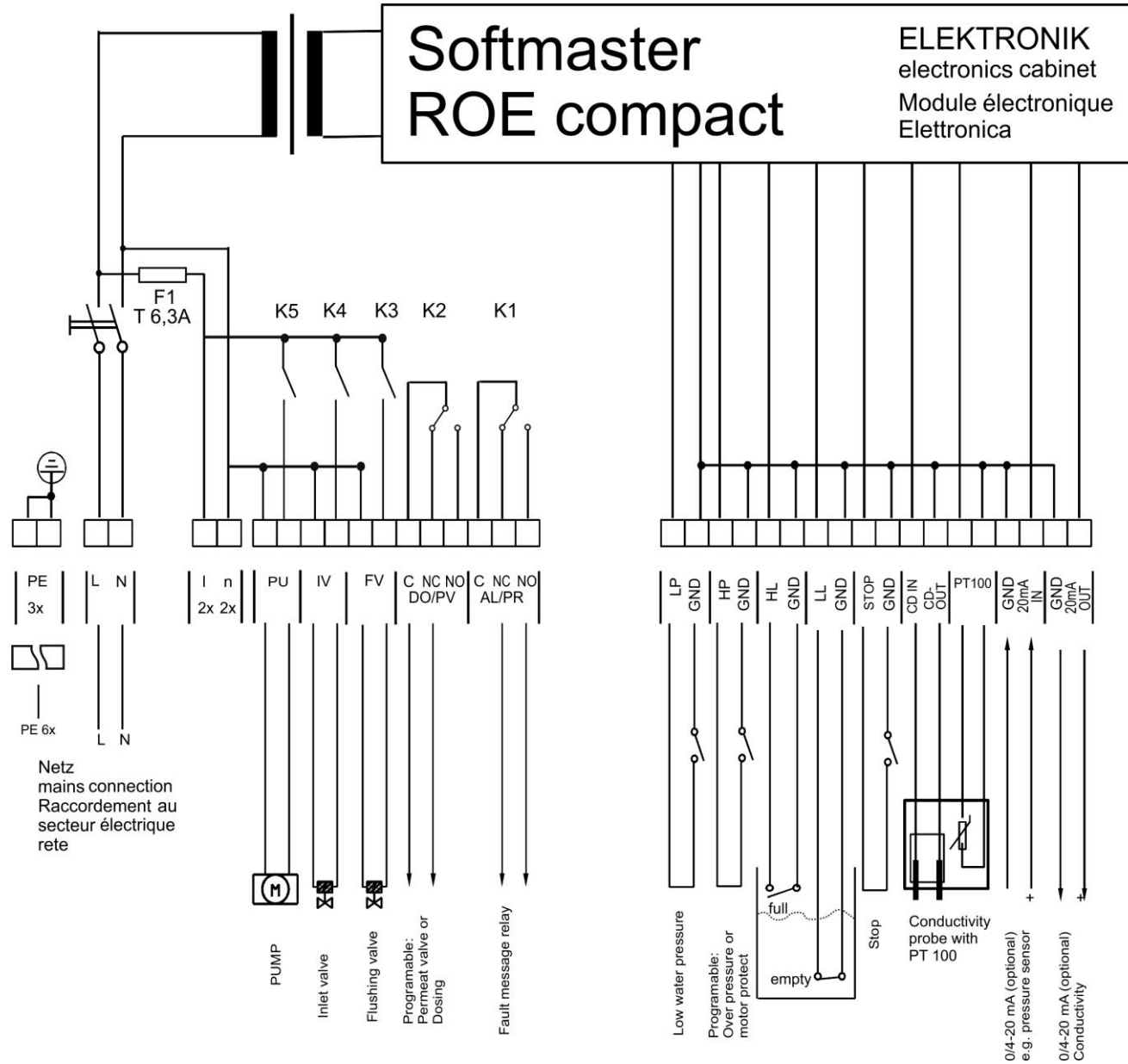

**Example for an osmosis plant layout**

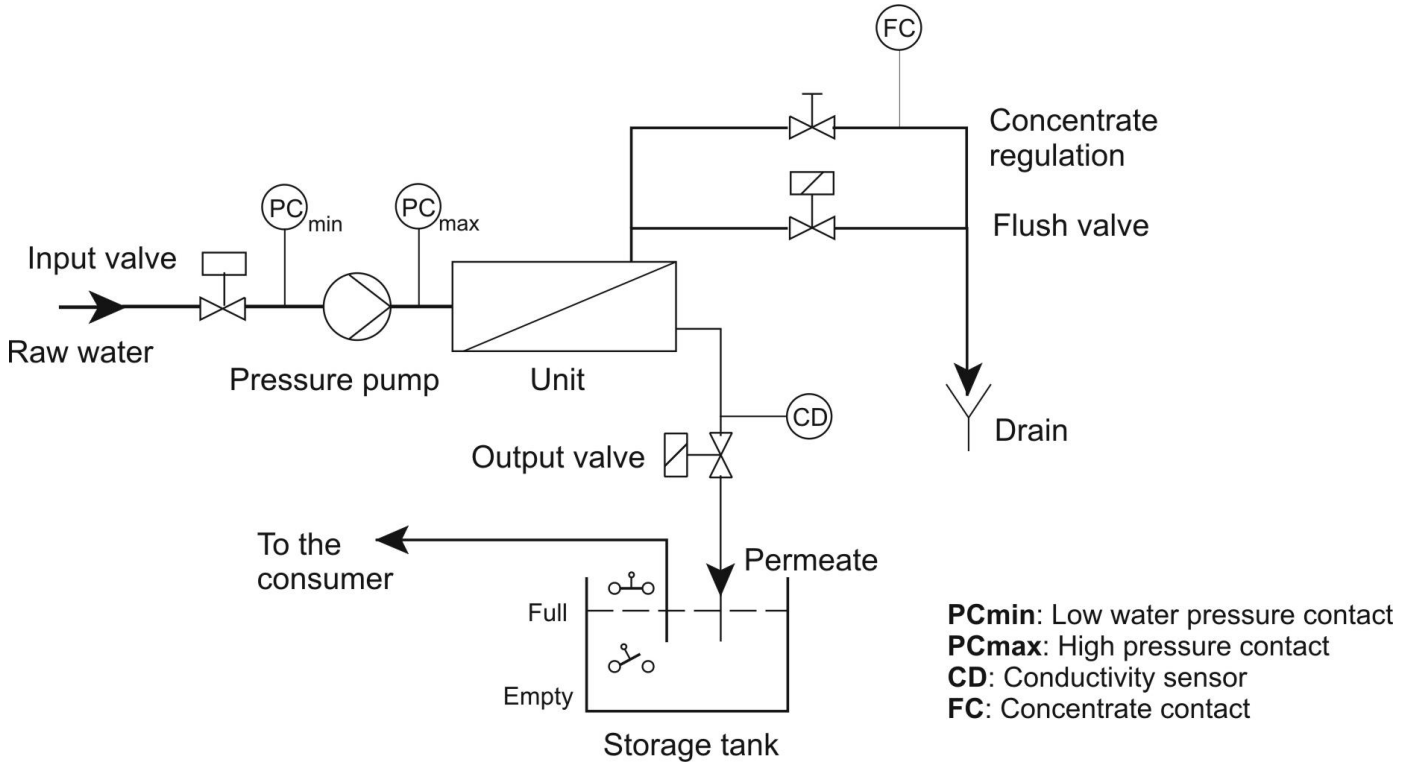

**Example of an osmosis plant layout – without flush valve operation**

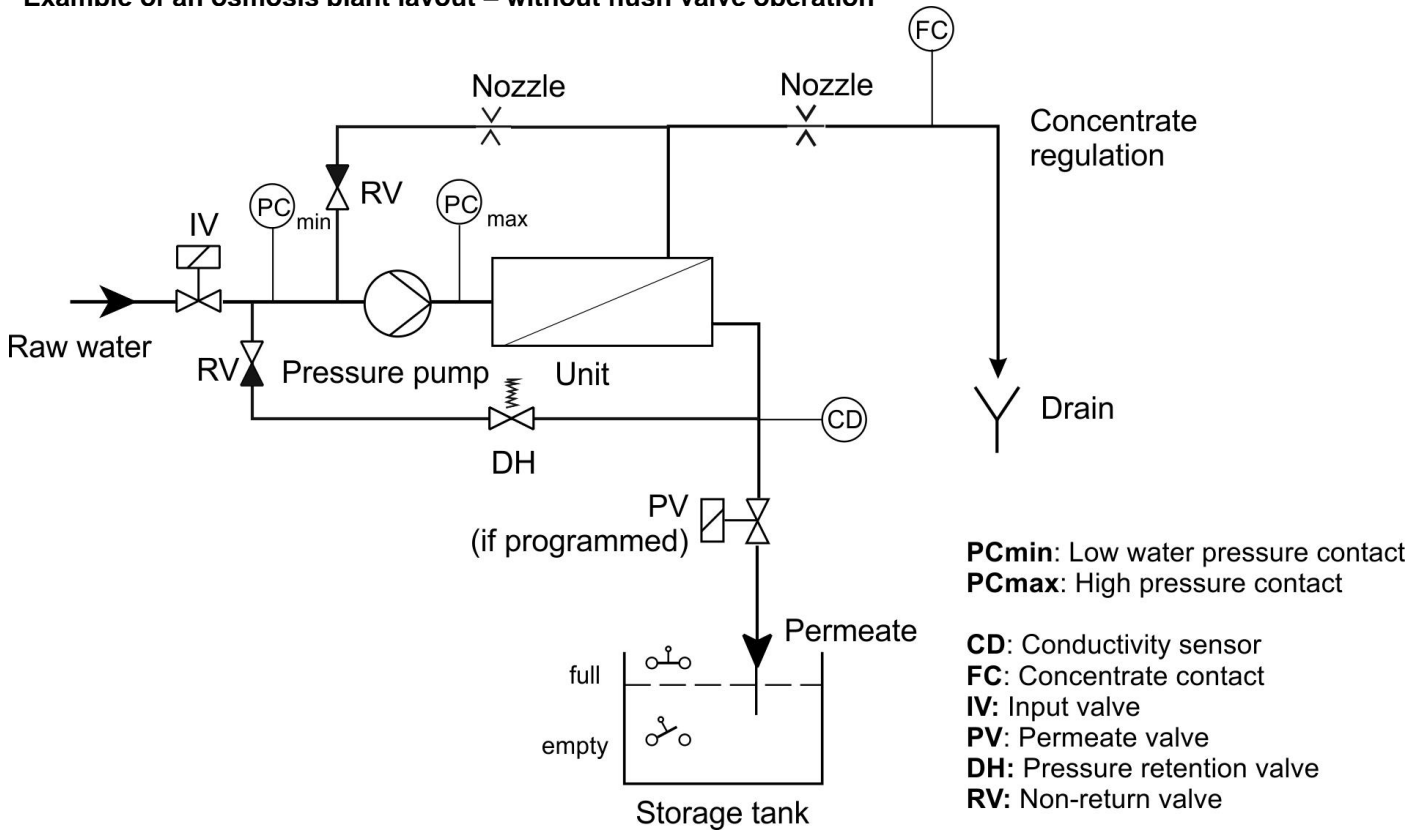

## Conformity Declaration



EC Conformity Declaration



### for the following product

#### **Softmaster ROE compact Controllers for reverse osmosis plants**

We hereby confirm that the above product conforms to the principal health and safety regulations laid down in the EC Directives 2014/30/EU and 2014/35/EU.

This declaration applies to all units produced in accordance with the attached manufacturing documents which are a constituent part of this declaration.

#### **The product was assessed with reference to the following standards:**



**EN 61000-6-4:** Electromagnetic compatibility, Generic emission standard

**EN 61000-6-2:** Electromagnetic compatibility, Generic immunity standard

**EN 61010-1:** Safety requirements for electrical equipment for measurement, control and laboratory use



**BS EN 61000-6-4+A1:** Electromagnetic compatibility, Generic emission standard

**BS EN 61000-6-2:** Electromagnetic compatibility, Generic immunity standard

**BS EN 61010-1+A1:** Safety requirements for electrical equipment for measurement, control and laboratory use

This declaration is made on behalf of

**GEBRÜDER HEYL  
Analysentechnik GmbH & Co. KG  
Orleansstraße 75b  
31135 Hildesheim**

by

Jörg-Tilman Heyl

General Manager

Hildesheim, 16/09/2021

## Technical data

**Power supply, depending on version:** Observe type plate!  
230 - 240 V or 24 V or 115V+/-10% / 50 -60 Hz,

**Power consumption without exterior load:** max. 9 VA

**Degree of protection:** IP54

**Protection class:** I

**Conformity:** EN 61000-6-2, EN 61000-6-4, EN 61010-1  
BS EN 61000-6-4+A1, BS EN 61000-6-2  
BS EN 61010-1+A1



**Ambient temperature:** 5 - 45°C

### Measuring ranges:

Measuring range	Cell constant	Sensor name, e.g.	art. no.
0,1 - 200 $\mu\text{S/cm}$	0,01 $\text{cm}^{-1}$	SOE0, STE0 PT100	310005 310110
1 - 2000 $\mu\text{S/cm}$	0,1 $\text{cm}^{-1}$	SO1, ST1 PT100, SOE1	310001 310120 310002
5 – 10000 $\mu\text{S/cm}$	0,5 $\text{cm}^{-1}$	SO5, SOE5, ST5 PT100	310003 310004 310121
10 – 20000 $\mu\text{S/cm}$	1,0 $\text{cm}^{-1}$	SO10	310014

### Accessories for calibration:

Conductivity solvent 1413  $\mu\text{S/cm}$  230 ml Art.-No.: 425404

### Housing dimensions:

B x H x D = approx. 257 x 214 x 135 mm  
Housing made of Polystyrol (PS),

### Weight:

Approx. 1.6 kg

### Fuse:

F1 T 6,3A (art. no 31597)  
0,1 A (230V) (art. no 31595)  
0,2 A (115V) (art. no 31584)  
1 A (24V) (art. no 31592)  
0,5 A (5/12V) (art. no 31604)  
0,16 (-12V) (art. no 31622)

**We reserve the right to make technical changes without notice in the interest of constantly improving our products!**

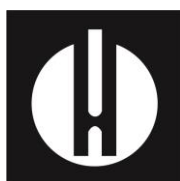

Gebrüder Heyl  
Analysentechnik GmbH & Co. KG  
Orleansstraße 75b  
D 31135 Hildesheim  
[www.heylanalysis.de](http://www.heylanalysis.de)



Scan the code and  
visit us on our website!